



DLC on Some Linear Models

Date: _____ Fixture: _____

QTY: _____ Project: _____

Thinline 3.18

Recessed T-Grid

Multiple Lens and Customizations Available

Architectural luminaire. Recessed mounting. Slim contemporary design. Continuous runs with lit corners available. L90 > 70K Hours. Designed and manufactured in North America. 10 Year Warranty.

Performance

Color Temp	Lm/W
4000K	120 Lm/W
3500K	116 Lm/W
3000K	112 Lm/W

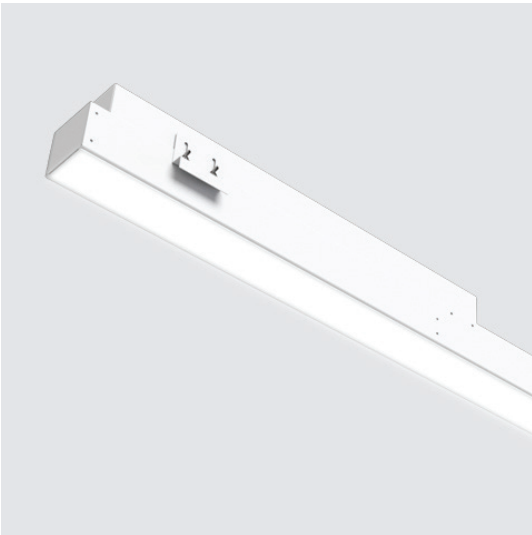

Ordering Options

MODEL	LENGTH	DIR LUMENS	CRI	COLOR TEMP	VOLTAGE	LENS	FINISH
DTL TG 3.18	CR _____ - Min 2' - Available in 6" increments - Unibody, up to 8'	D 250	80	27K 2700K	U 120/277V	FR Frosted	WH White
		D 500	90	3K 3000K	H 347V	FRREG Frosted Regressed	CU Custom
		D 750		35K 3500K		ASY Asymmetric	
		D 1000		4K 4000K		.5" FR DROP	
		D _____ Custom Up to 1200		5K 5000K		1.5" FR DROP	

DTL TG 3.18							
-------------	--	--	--	--	--	--	--

DRIVER	CONTROLS	ACCESSORIES
DIMOFF 0-10 1% DIMOFF Driver	N None	N None
LUTRON Lutron Ecosystem Driver	DMX	10kV 10kV Surge Protection
SR Philips SR	SNS Philips SNS 300 w/ BLD & Daylight	EMBAT 6W 90 Min BAT
DALI	CLM Encelium CLM	
ELDO .1% ELDO LED Driver	LG LG Dongle	
* 347 only in 1 - 10 5%	BT Bluetooth Mesh	
	EN Enlighted Integral	

--	--	--	--

SAMPLE: DTL TG 3.18 - CR8 - 500 - 80 - 35K - U - FR - WH - DIMOFF - N - N

Available with BIOS® (please consult factory)

Specifications subject to change without notice.

Note: Not all products are qualified on the DLC QPL. To view our DLC qualified products, please consult the DLC qualified products list at www.designlights.org/qpl.

10YR
WARRANTY

LED

L90 > 70,000

Samsung 301 3 McAdam Binning

4000K 120 Lm/W

3500K 98%

3000K 96%

90 CRI 85%

Optics

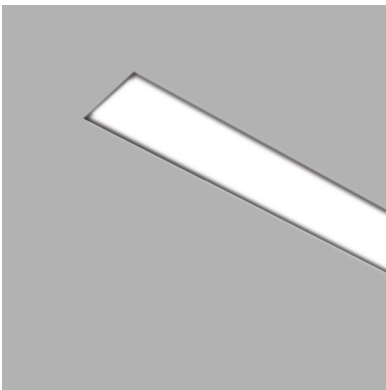

Flat

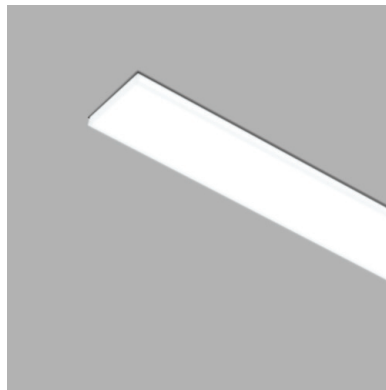

0.5" Drop Lens

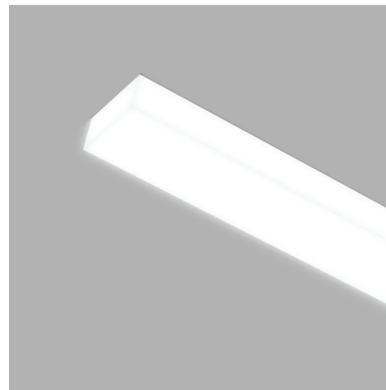

1.5" Drop Lens

Lens Options

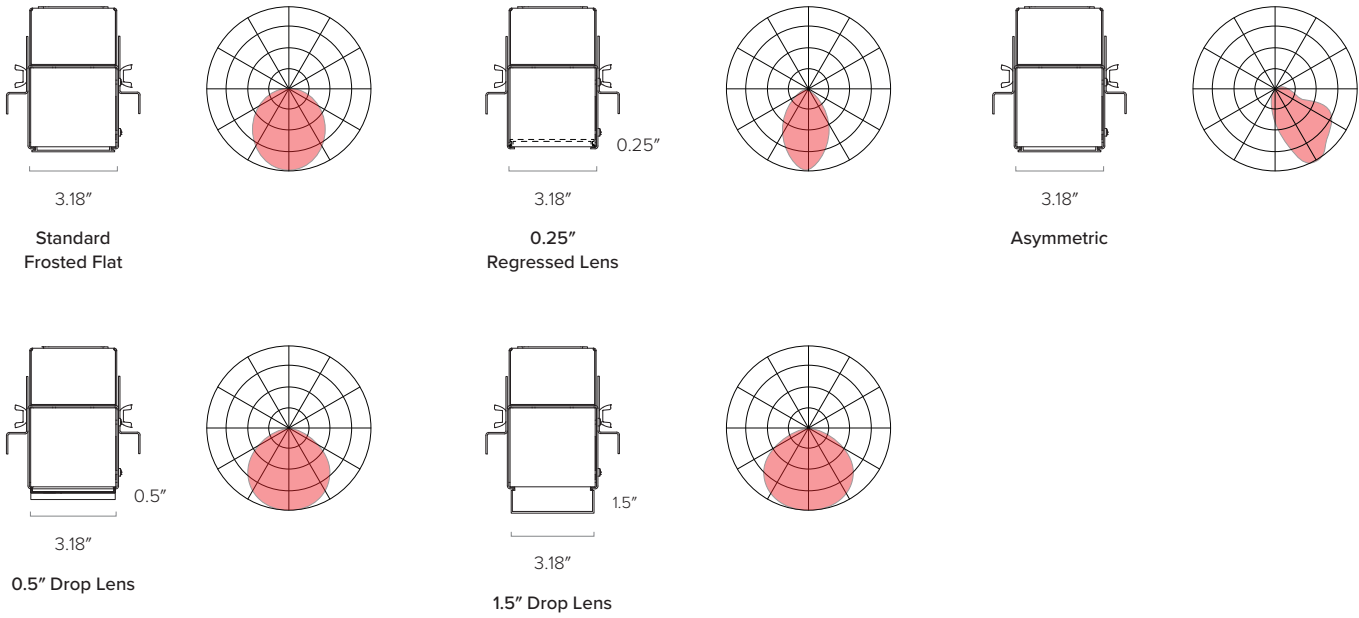

Measurements

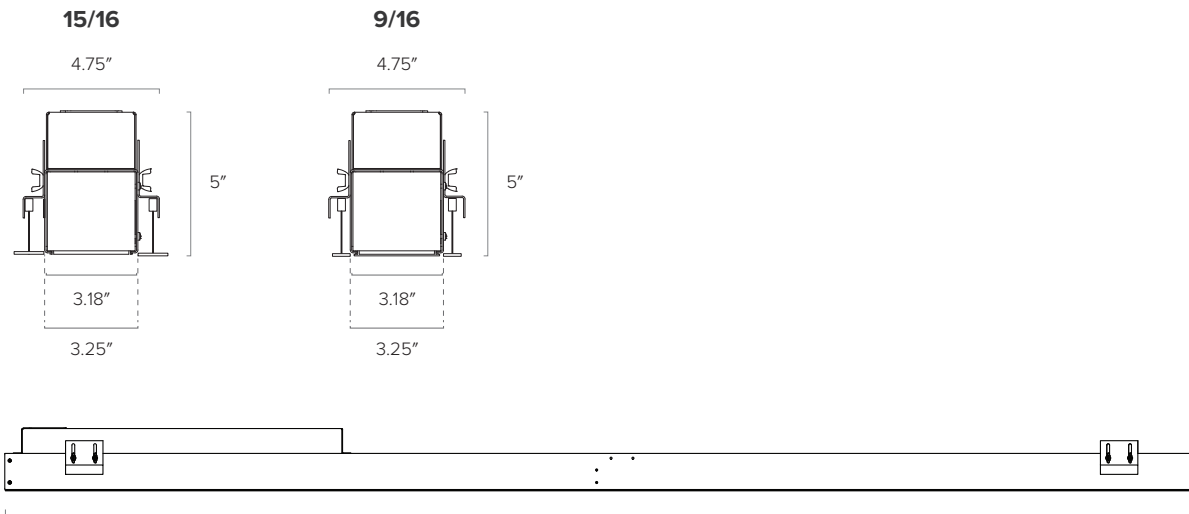

2': 23.75", 3': 35.75", 4': 47.75", 5': 61.4", 6': 71.75", 7': 83.75", 8': 96.75"

Note: Dimensions are for reference only. Please make measurements for actual dimensions

Lit Corner Hubs



Lit Corner 90°

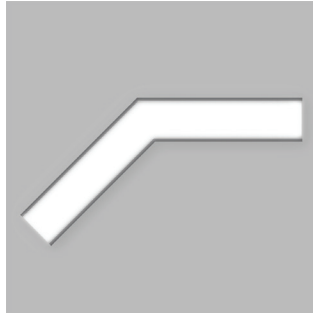

Lit Corner 135°



T-Hub



Y-Hub



X-Hub

**** Custom Available ****

Lit Corner Hubs - Shapes

Sample Configurations

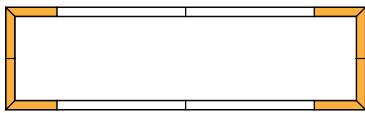

Lit Corner Hub 90°

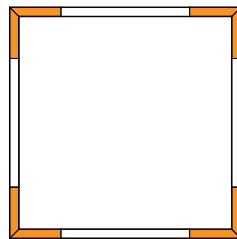

Lit Corner Hub 90°

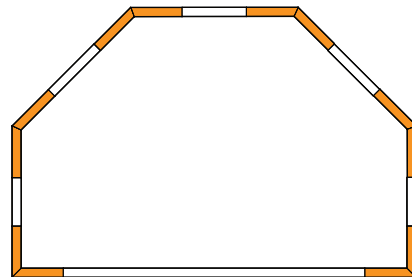

Lit Corner Hub 90° & Lit Corner Hub 135°

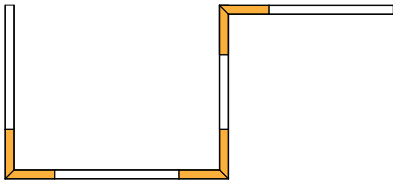

Lit Corner Hub 90°



Lit Corner Hub 90°

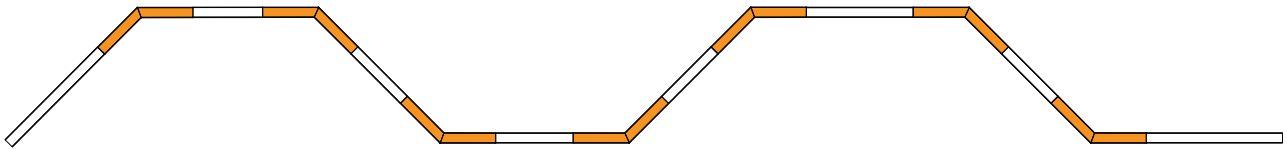

Lit Corner Hub 135°

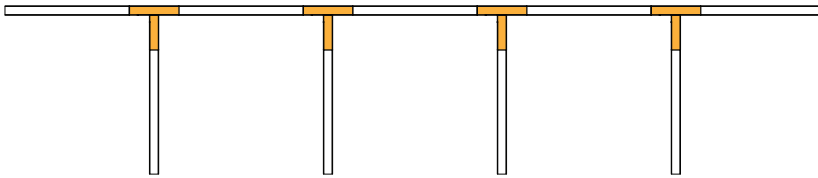

Lit Corner T-Hub

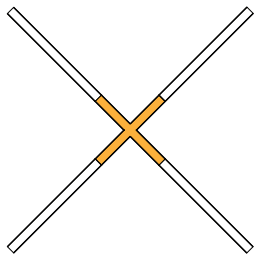

Lit Corner X-Hub

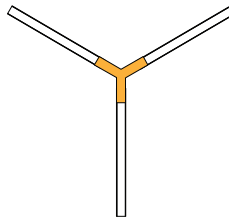

Lit Corner Y-Hub