

Date	Fixture	Project	Quantity
------	---------	---------	----------

Zip Eco

Linear Strip Light

Features

- LED linear light fixture
- Pendant and surface mounting options
- 2', 4', and 8' lengths
- Continuous run options
- Enclosed lens prevents penetration of dust, insects, and other debris into the lamp compartment
- Dry and damp rated
- Designed and Manufactured in North America
- 5 Year Warranty

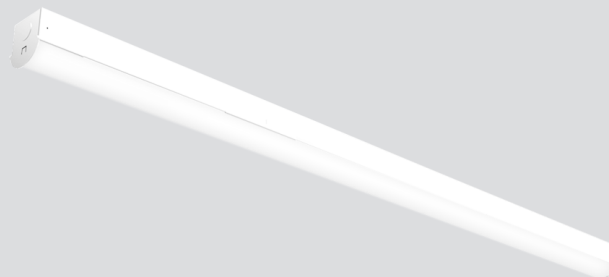

Specifications

Construction

Aluminum Housing
Power Coated Finish

Dimensions:

Zip Eco 2: 2.352"W x 2.443"H x 23.53"L
Zip Eco 4: 2.352"W x 2.443"H x 46.05"L
Zip Eco 8: 2.352"W x 2.443"H x 91.05"L

LED

Samsung LM281B Plus Pro, 3-Step MacAdam Binning
200,000+ Life Hours (L70)

Efficacy

Zip Eco 2: 151 Lm/W
Zip Eco 4: Up to 151 Lm/W
Zip Eco 8: Up to 153 Lm/W

Watts

Zip Eco 2: 20W, 30W
Zip Eco 4: 20W - 80W
Zip Eco 8: 40W - 120W

Color Temperature

3000K - 5000K

CRI

80 or 90

Voltage

120/277V or 347V

Controls

0-10V Dimming down to 1%

Operating Temperature

-35°C to +45°C | -31°F to +113°

Lens

Frosted

Mounting

Aircraft Cable (10' std)
V-Hooks
Surface
Continuous Run

Accessories

Occupancy Sensor (on/off)
Integral Programmable Microwave Sensor
10kV Surge Protection
Emergency Battery
Wire Guard
Reflector

Wiring

Black or White Flexible Cord
Internal

Finishes

White - RAL 9003

Certifications

DLC
cULus

Not all products are qualified on the DLC QPL. To view our DLC qualified products, please consult the DLC qualified products list at www.designlights.org/qpl.



Ordering Guide

Sample Configuration: Zip - 8 - 60 - 80 - 4K - U - FR - WH - V - BFC - N - ECO

ZIP						FR	WH		
Model	Length	Watts	CRI	Color Temp	Voltage	Lens	Finish	Mounting	Wiring
	ECO								
Accessories	Type								

Model	Length	Watts	CRI	Color Temp	Voltage	Lens	Finish
ZIP	2	20, 30	80	3K - 3000K	U - 120/277V	FR - Frosted	WH - White
	4	20, 30, 40, 60, 80	90	35K - 3500K	H - 347V		
	8	40, 60, 80, 100, 120		4K - 4000K 5K - 5000K			

Mounting	Wiring	Accessories	Type
AC - Aircraft Cable 6' std V - V Hooks SU - Surface <i>Optional</i> CR - Continuous Run	IN - Internal BFC - Black Flexible Cord WFC - White Flexible Cord	N - None <i>Optional</i> OCC - Occupancy Sensor (on/off) EM - Emergency Battery 10kV - 10kV Surge Protection MICRO - Microwave Sensor -External (with BLD and Daylight Harvesting options) WG - Wire Guard RFL - Reflector	ECO

Note: For custom configurations please contact factory

Dimensions



W: 2.35"
H: 2.44"

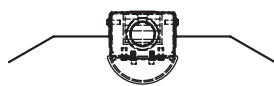

W: 9.99"
H: 2.44"
Zip w/ Reflector



L: 2': 23.53" | 4': 46.05" | 8': 91.05"

Zip Eco 4 w/ Reflector

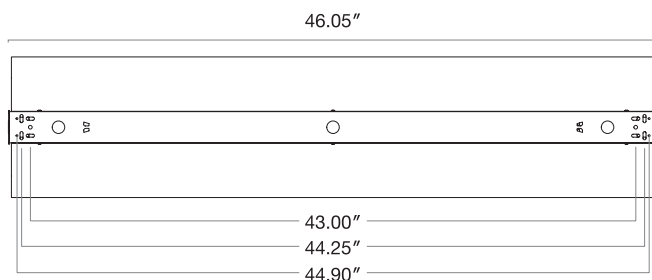

Zip Eco 8 w/ Reflector

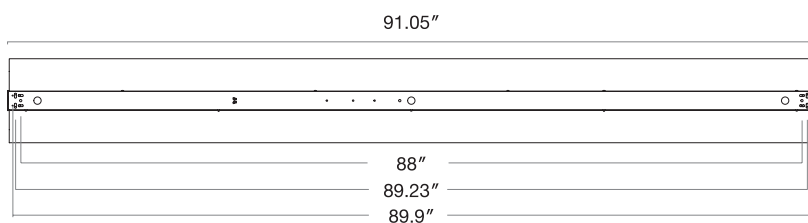

Note: Zip Eco 2 - Please contact Factory

Wire Guard Option

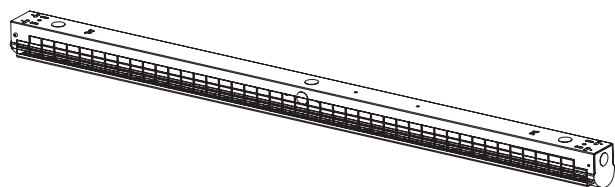

Output Performance at 4K

Model	Watts	Lm/W	Delivered Lumens
Zip Eco 2 20	19.63	151	2965
Zip Eco 2 30	29.75	149.2	4413

Model	Watts	Lm/W	Delivered Lumen
Zip Eco 4 20	18.9	146	2762
Zip Eco 4 30	29.08	150.6	4379
Zip Eco 4 40	39.26	151	5929
Zip Eco 4 60	59.14	149.2	8826
Zip Eco 4 80	79.26	149	11810

Model	Watts	Lm/W	Delivered Lumens
Zip Eco 8 40	39.26	151	5928
Zip Eco 8 60	59.24	150	8886
Zip Eco 8 80	79.26	151	11968
Zip Eco 8 100*	99.38	152	15105
Zip Eco 8 120	119.26	153.2	18269

Note: Zip 8 100 - 120/277V Only

Photometrics

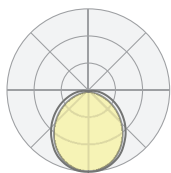

ZONAL LUMEN SUMMARY

Zone	Lumens	% of Fixture
0° - 30°	3781	26%
0° - 60°	10647	73%
0° - 90°	14099	96%
90° - 120°	523	4%
90° - 150°	565	4%
90° - 180°	565	4%
0° - 180°	14665	100%
20° - 50°	6713	46%

ZONAL LUMEN SUMMARY

Zone	Lumens
0° - 10°	471
10° - 20°	1325
20° - 30°	1986
30° - 40°	2344
40° - 50°	2384
50° - 60°	2138
60° - 70°	1682
70° - 80°	1132
80° - 90°	638
90° - 100°	313
100° - 110°	147
110° - 120°	63
120° - 130°	26
130° - 140°	11
140° - 150°	4
150° - 160°	1
160° - 170°	0
170° - 180°	0

Pendant Mounting

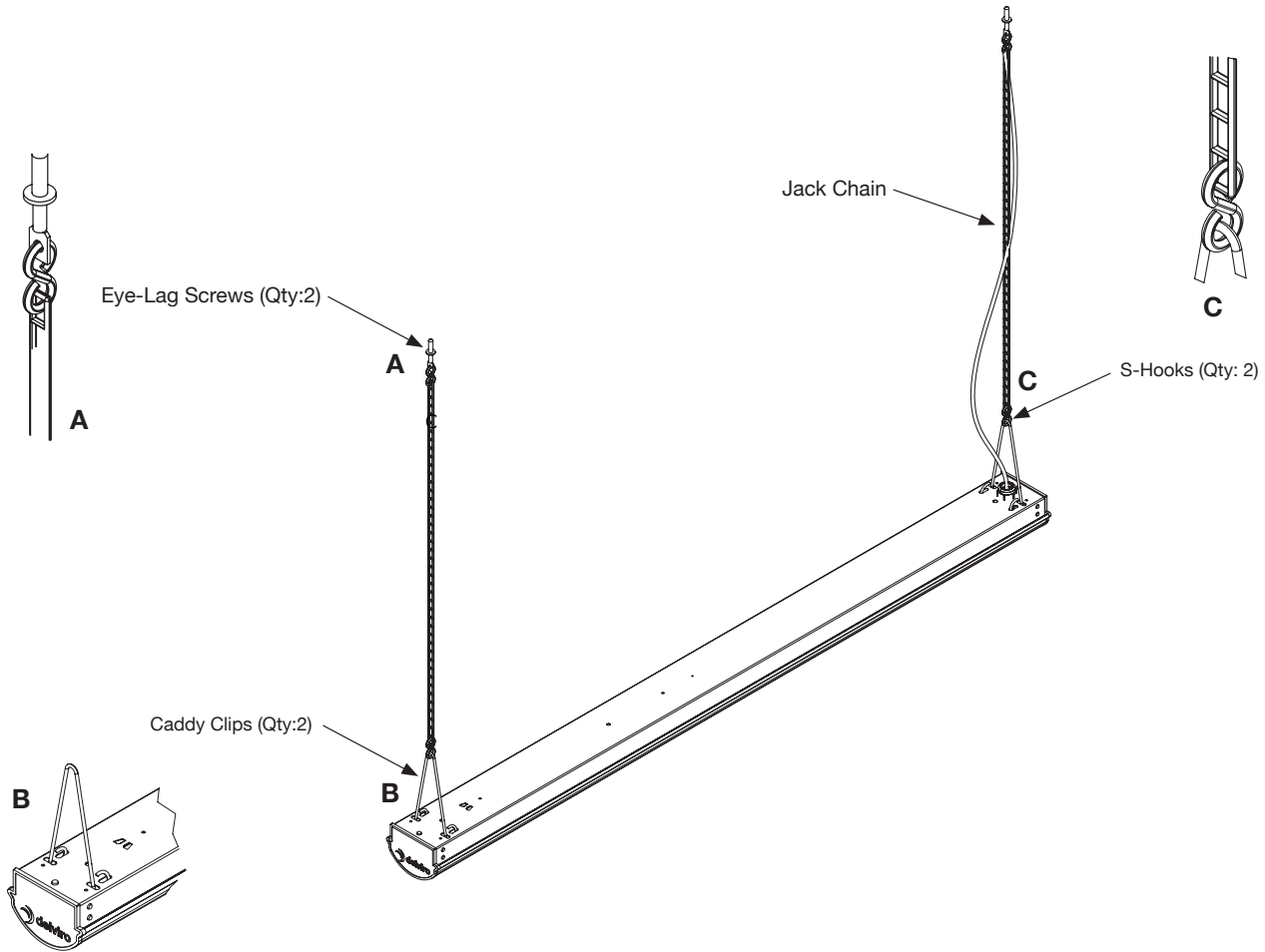

Surface Mounting

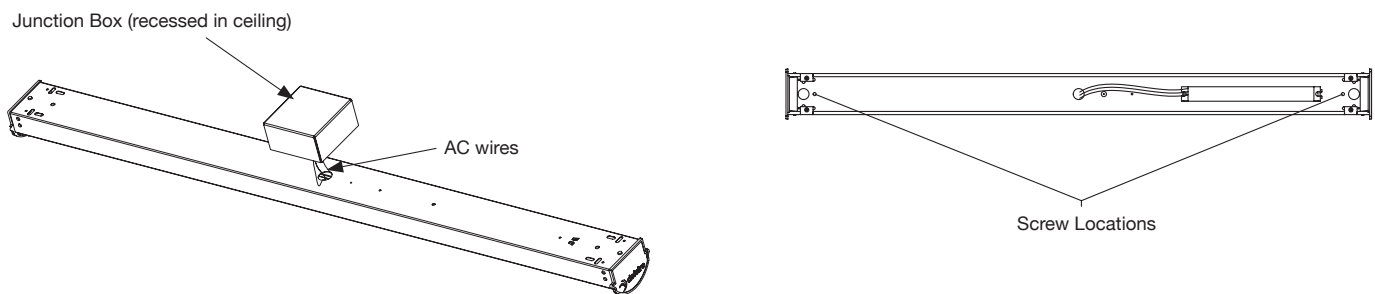

Continuous Run Installation

