

Fixture: _____ QTY: _____ Project : _____

Thinline Double T 60/120

Suspended Direct | Direct/Indirect

Architectural luminaire. 60/120° T Shaped luminaire. Pendant mounting. Direct and direct-indirect distribution options. Available in 3 sizes. 2.25" wide. Multiple finishes.

cULus Listed

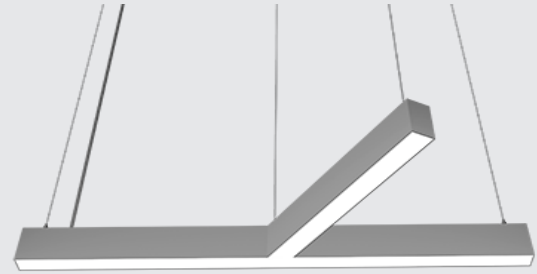
 Designed and manufactured in North America
 5 Year Warranty

Performance

4000K - 120 Lm/W | 3500K - 116 Lm/W | 3000K - 112 Lm/W



Ordering Options

Sample Configuration: DTL T 60/120 - 4FT x 2FT - D 500 - I 500 - 90 - 4K - U - FR - FR - WH - AC - DIMOFF - N - 2 - N - 5 WIRE - CL - 6 - WH

Model	Size	Direct Lm/ft	Indirect Lm/ft	CRI	Color Temp	Voltage	Direct Lens
DTL T 90	4FT x 2FT	D 250	I 250	80	27K 2700K	U 120/277V	FR Frosted Flat
	6FT x 3FT	D 500	I 500	90	3K 3000K	H 347V	FRREG Frosted Regressed
	8FT x 4FT	D 750	I 750		35K 3500K		
		D 1000	I 1000		4K 4000K		
	-Custom Sizes Available - Please Consult Factory	D _____ (custom up to 1200)	I _____ (custom up to 1200)		5K 5000K		
DTL T 90	<input type="text"/>	<input type="text"/>	<input type="text"/>	<input type="text"/>	<input type="text"/>	<input type="text"/>	<input type="text"/>

Indirect Lens	Finish	Mounting	Driver	Controls
FR Frosted BATWING Batwing	WH White BLK Black GRY Grey CU Custom	AC Aircraft Cable 10' Standard	DIMOFF 0-10V DIMOFF <i>Optional</i> DALI LUTRON SR ELDO Lutron Ecosystem Philips SR .1% ELDO (347 only 1-10 5%)	N None <i>Optional</i> DMX SNS Philips SNS 300 w/BLD & Daylight CLM Encelium CLM LG LG Dongle BT Bluetooth Mesh EN Enlighted Integral
<i>Indirect Lens: Minimum size 4FT x 2FT</i>		- Contact factory for custom finishes		
<input type="text"/>	<input type="text"/>	<input type="text"/>	<input type="text"/>	<input type="text"/>

Circuits	Accessories	Wiring	Wire Color	Wire Length	Canopy Color
1 1 Circuit 2 2 Circuits	N None <i>Optional</i> 10kV 10kV Surge Protection EM Emergency Battery +GTD Generator Transfer Device	5 WIRE 5 Wire(std) <i>Optional</i> N 5 Leads 6 WIRE 6 Wire - Cable (EM - emergency battery option)	CL Clear <i>Optional</i> B Black W White	Length(Ft) - 6Ft Standard	WH White BLK Black CU Custom - Consult factory for custom finishes
<input type="text"/>	<input type="text"/>	<input type="text"/>	<input type="text"/>	<input type="text"/>	<input type="text"/>

LED

L90>70,000

Samsung 301 3-Step MacAdam Binning

4000K 120 Lm/W

3500K 98%

3000K 96%

90 CRI 85%

Lens Options - Direct Distribution

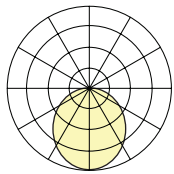

Standard
Frosted Flat

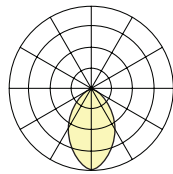

Frosted
0.25" Regressed

Lens Options - Indirect Distribution

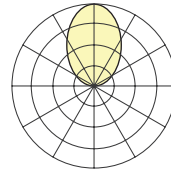

Standard
Frosted

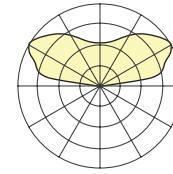

Batwing

Dimensions

T 60°

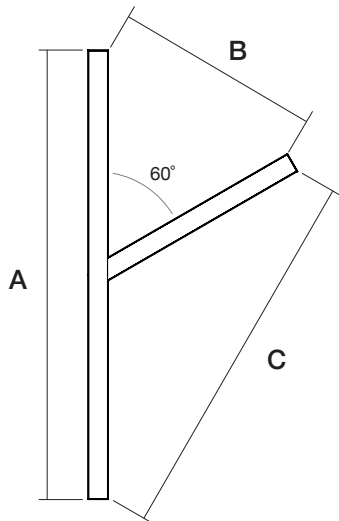

Model 60°	A	B	C
4FT x 2FT	48.7"	22.4"	41.1"
6FT x 3FT	72.7"	34.4"	61.8"
8FT x 4FT	96.7"	50.3"	84.4"

T 120°

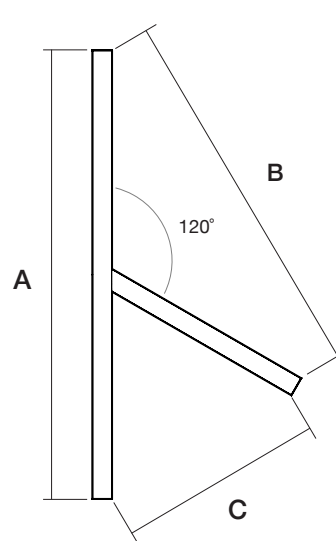

Model 120°	A	B	C
4FT x 2FT	48.7"	22.4"	41.1"
6FT x 3FT	72.7"	61.8"	34.4"
8FT x 4FT	96.7"	46.4"	82.6"

Mounting

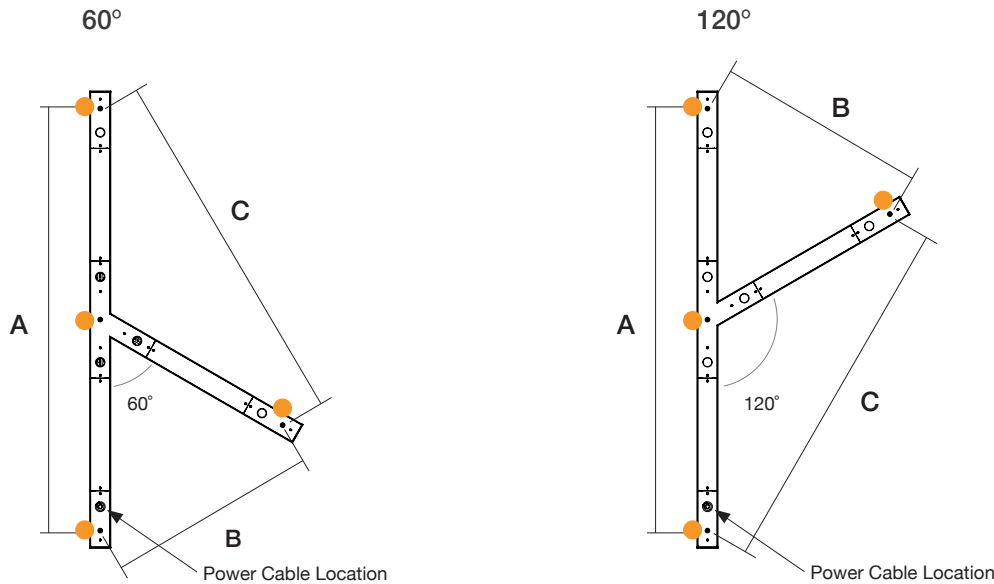

● Mounting Locations

Model 60°	A	B	C
4FT x 2FT	45"	22.5	38.9"
6FT x 3FT	69.0"	34.5	59.8"
8FT x 4FT	93.0"	46.5"	80.5"

Model 120°	A	B	C
4FT x 2FT	45.0"	22.5"	39.9"
6FT x 3FT	69.0"	34.5"	59.8
8FT x 4FT	93.0"	46.5"	80.5"

Finish Options

Standard Finishes



Grey
RAL 7046
Sandtex



White
RAL 9003
Sandtex



Black
RAL 9004
Sandtex

Custom Finishes



Orange
RAL 2009
Sandtex



Green
RAL 6010
Sandtex



Blue
RAL 5012
Sandtex



Yellow
RAL 1037
Sandtex

Additional finishes - Please contact factory