

Fixture: _____ QTY: _____ Project : _____

Thinline U 60/120

Suspended

Direct | Direct-Indirect

Architectural luminaire. 60/120° U Shaped fixture. Pendant mounting. Direct and direct-indirect distribution options. Available in 2 sizes. 2.25" wide. Multiple finishes available.

cULus Listed

Designed and manufactured in North America.
5 Year Warranty.

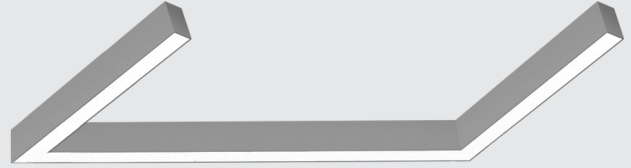

Performance

4000K - 120 Lm/W | 3500K - 116 Lm/W | 3000K - 112 Lm/W



Ordering Options

Sample Configuration: DTL U 60/120 - 2FT x 2FT - D 500 - I 500 - 90 - 4K - U - FR - FR - WH - AC - DIMOFF - N - 2 - N - 5 WIRE - CL - 6 - WH

Model	Size	Direct Lm/ft	Indirect Lm/ft	CRI	Color Temp	Voltage	Direct Lens
DTL U 60/120	4FT x 2FT	D 250	I 250	80	27K 2700K	U 120/277V	FR Frosted Flat
	6FT x 3FT	D 500	I 500	90	3K 3000K	H 347V	FRREG Frosted Regressed
	-Custom Sizes Available - Please Consult Factory	D 750	I 750		35K 3500K		
		D 1000	I 1000		4K 4000K		
		D _____	I _____		5K 5000K		
		(custom up to 1200)	(custom up to 1200)				

Indirect Lens	Finish	Mounting	Driver	Controls
FR Frosted	WH White	AC Aircraft Cable	DIMOFF 0-10V DIMOFF	N None
BATWING Batwing	BLK Black	10' Standard	<i>Optional</i>	<i>Optional</i>
<i>Indirect Lens: Minimum size 4FT x 2FT</i>	GRY Grey		DALI	DMX
	CU Custom		LUTRON Lutron Ecosystem	SNS Philips SNS 300 w/BLD & Daylight
	- Contact factory for custom finishes		SR Philips SR	CLM Encelium CLM
			ELDO .1% ELDO (347 only 1-10 5%)	LG LG Dongle
				BT Bluetooth Mesh
				EN Enlighted Integral

<input type="text"/>	<input type="text"/>	AC	<input type="text"/>	<input type="text"/>
----------------------	----------------------	-----------	----------------------	----------------------

Circuits	Accessories	Wiring	Wire Color	Wire Length	Canopy Color
1 1 Circuit	N None	5 WIRE 5 Wire(std)	CL Clear	Length(Ft)	WH White
2 2 Circuits	<i>Optional</i>	<i>Optional</i>	<i>Optional</i>	- 6Ft Standard	BLK Black
	10kV 10kV Surge Protection	N 5 Leads	B Black		CU Custom
	EM Emergency Battery	6 WIRE 6 Wire - Cable (EM - emergency battery option)	W White		- Consult factory for custom finishes
	+GTD Generator Transfer Device				

<input type="text"/>	<input type="text"/>	<input type="text"/>	<input type="text"/>	<input type="text"/>	<input type="text"/>
----------------------	----------------------	----------------------	----------------------	----------------------	----------------------

LED

L90>70,000

Samsung 301 2 McAdam Binning

4000K 120 Lm/W

3500K 98%

3000K 96%

90 CRI 85%

Lens Options - Direct Distribution

Lens Options - Indirect Distribution

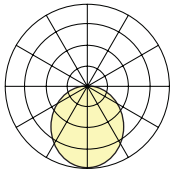

Standard
Frosted Flat

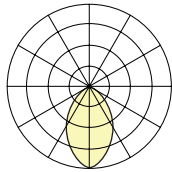

Frosted
0.25" Regressed

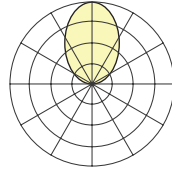

Standard
Frosted

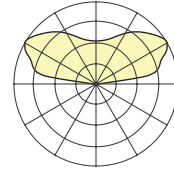

Batwing

Dimensions

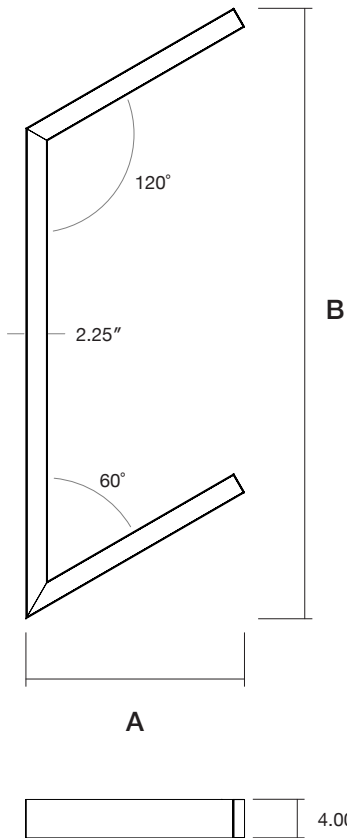

Model	A	B
4FT x 2FT	22.8"	51.1"
6FT x 3FT	33.2"	75.1"

Mounting

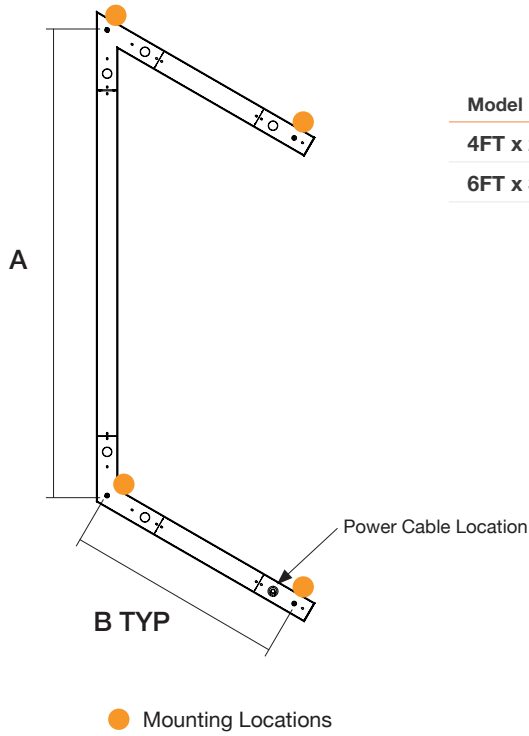

Model	A	B
4FT x 2FT	48.5"	22.5"
6FT x 3FT	72.5"	34.5"

Finish Options

Standard Finishes



Grey
RAL 7046
Sandtex



White
RAL 9003
Sandtex



Black
RAL 9004
Sandtex

Custom Finishes



Orange
RAL 2009
Sandtex



Green
RAL 6010
Sandtex



Blue
RAL 5012
Sandtex



Yellow
RAL 1037
Sandtex

Additional finishes - Please contact factory