

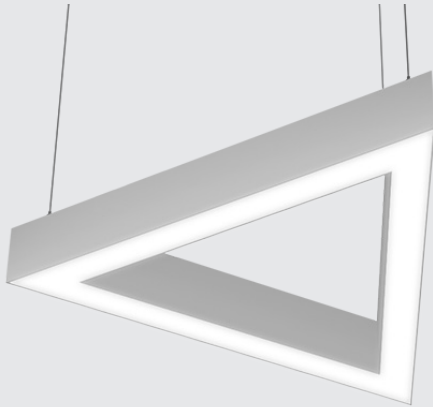

Date: _____ Fixture: _____

QTY: _____ Project: _____



Thinline Triangle

Suspended Direct | Direct-Indirect

Architectural luminaire. Triangular shaped design. Pendant mounting. Direct and Direct-Indirect distribution options. 3 standards sizes. Additional sizes available. 2.25" wide.

Multiple finishes.
cULus Listed.

Designed and manufactured in North America.
5 Year Warranty.

Ordering Options

Model	Size	Direct Lm/ft	Indirect Lm/ft	CRI	Color Temp	Voltage	Direct Lens
DTL TRI	3 x 2FT	D 250	I 250	80	27K 2700K	U 120/277V	FR Frosted
	3 x 3FT	D 500	I 500	90	3K 3000K	H 347V	FRREG Frosted Regressed
	3 x 4FT	D 750	I 750		35K 3500K		
		D 1000	I 1000		4K 4000K		
	Custom Sizes Available - Please Consult Factory	D _____ (custom up to 1200)	I _____ (custom up to 1200)		5K 5000K		

DTL TRI							
---------	--	--	--	--	--	--	--

Indirect Lens	Finish	Mounting	Driver	Controls	Circuits
FR Frosted BATWING Batwing	GRY Grey WH White BLK Black CU Custom	AC Aircraft Cable 10' Std	DIMOFF 0-10 1% DIMOFF LUTRON Lutron Ecosystem SR Philips SR DALI ELDO .1% ELDO (347 only 1-10 5%)	N None DMX SNS Philips SNS 300 w/BLD & Daylight CLM Encelium CLM LG LG Dongle BT Bluetooth Mesh EN Enlighted Integral	1 1 Circuit 2 2 Circuits

Indirect Lens: Minimum size 2FT x 2FT

		AC			
--	--	----	--	--	--

Accessories	Wiring	Wire Color	Wire Length	Canopy Color
N None 10kV 10kV Surge Protection EMBAT 6W 90 Min Battery	N None BFC3 3 Wire Cord Black WFC3 3 Wire Cord White IN3 3 Wire Internal IN5 5 Wire Internal CFC Architectural Cable - 5 Wire BFC5 5 Wire Cord Black WFC5 5 Wire Cord White	G Grey W White B Black C Clear	_____ FT (6FT Standard)	WH White BLK Black CU Custom

--	--	--	--	--

Sample: DTL TRI - 2FT x 2FT - D 500 - I 500 - 90 - 4K - U - FR - GRY - AC - DIMOFF - N - 1 - N - N - G - 6 - WH

LED

L90 > 70,000
 Samsung 301 3 McAdam Binning
 4000K 120 Lm/W
 3500K 98%
 3000K 96%
 90 CRI 85%

Performance

Model	Lm/W
4000K	120 Lm/W
3500K	116 Lm/W
3000K	112 Lm/W

Dimensions

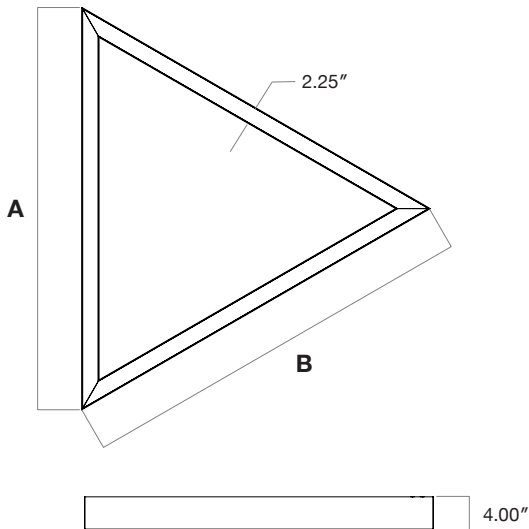

MODEL	A	B
3 x 2FT	28.4"	28.4"
3 x 3FT	40.4"	40.4"
3 x 4FT	52.4"	52.4"

Mounting

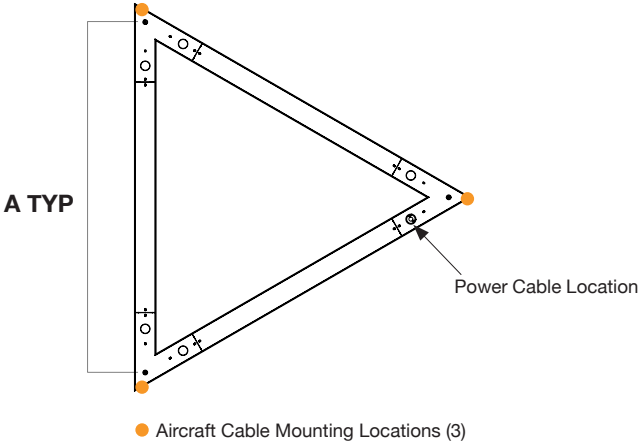





MODEL	A
2 x 2FT	24.5"
3 x 3FT	36.5"
4 x 4FT	48.5"

Finish Options

Standard Finishes

 <p>Grey RAL 7046 Sandtex</p>	 <p>White RAL 9003 Sandtex</p>	 <p>Black RAL 9004 Sandtex</p>
--------------------------------------------------------------------------------------------------------------------------	---------------------------------------------------------------------------------------------------------------------------	---------------------------------------------------------------------------------------------------------------------------

Custom Finishes

 <p>Orange RAL 2009 Sandtex</p>	 <p>Green RAL 6010 Sandtex</p>	 <p>Blue RAL 5012 Sandtex</p>	 <p>Yellow RAL 1037 Sandtex</p>
----------------------------------------------------------------------------------------------------------------------------	---------------------------------------------------------------------------------------------------------------------------	--------------------------------------------------------------------------------------------------------------------------	----------------------------------------------------------------------------------------------------------------------------

Additional finishes - Please contact factory