

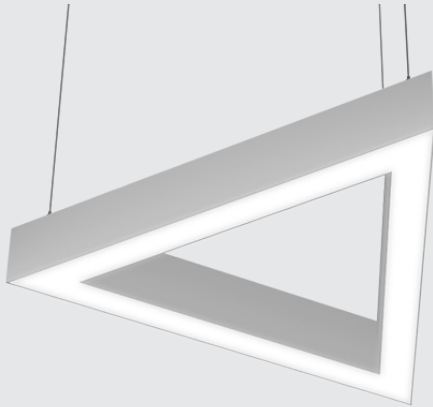

Date: _____ Fixture: _____

QTY: _____ Project: _____



Thinline Triangle

Suspended Direct | Direct-Indirect

Architectural luminaire. Triangular shaped design. Pendant mounting. Direct and Direct-Indirect distribution options. 3 standards sizes. Additional sizes available. 2.25" wide.

Multiple finishes.
cULus Listed.

Designed and manufactured in North America.
5 Year Warranty.

Ordering Options

Model	Size	Direct Lm/ft	Indirect Lm/ft	CRI	Color Temp	Voltage	Direct Lens
DTL TRI	2 x 2FT	D 250	I 250	80	27K 2700K	U 120/277V	FR Frosted
	3 x 3FT	D 500	I 500	90	3K 3000K	H 347V	FRREG Frosted Regressed
	4 x 4FT	D 750	I 750		35K 3500K		
		D 1000	I 1000		4K 4000K		
	Custom Sizes Available - Please Consult Factory	D _____ (custom up to 1200)	I _____ (custom up to 1200)		5K 5000K		

DTL TRI							
---------	--	--	--	--	--	--	--

Indirect Lens	Finish	Mounting	Driver	Controls	Circuits
FR Frosted	GRY Grey	AC Aircraft Cable	DIMOFF 0-10 1% DIMOFF	N None	1 1 Circuit
BATWING Batwing	WH White	10' Std	LUTRON Lutron Ecosystem	DMX	2 2 Circuits
	BLK Black		SR Philips SR	SNS Philips SNS 300 w/BLD & Daylight	
	CU Custom		DALI	CLM Encelium CLM	
			ELDO .1% ELDO (347 only 1-10 5%)	LG LG Dongle	
				BT Bluetooth Mesh	
				EN Enlighted Integral	

		AC			
--	--	----	--	--	--

Accessories	Wiring	Wire Color	Wire Length	Canopy Color
N None	N None	G Grey	_____ FT (6FT Standard)	WH White
10kV 10kV Surge Protection	BFC3 3 Wire Cord Black	W White		BLK Black
EMBAT 6W 90 Min Battery	WFC3 3 Wire Cord White	B Black		CU Custom
	IN3 3 Wire Internal	C Clear		
	IN5 5 Wire Internal			
	CFC Architectural Cable - 5 Wire			
	BFC5 5 Wire Cord Black			
	WFC5 5 Wire Cord White			

--	--	--	--	--

Sample: DTL TRI - 2FT x 2FT - D 500 - I 500 - 90 - 4K - U - FR - GRY - AC - DIMOFF - N - 1 - N - N - G - 6 - WH

LED

L90 > 70,000
 Samsung 301 3 McAdam Binning
 4000K 120 Lm/W
 3500K 98%
 3000K 96%
 90 CRI 85%

Performance

Model	Lm/W
4000K	120 Lm/W
3500K	116 Lm/W
3000K	112 Lm/W

Dimensions

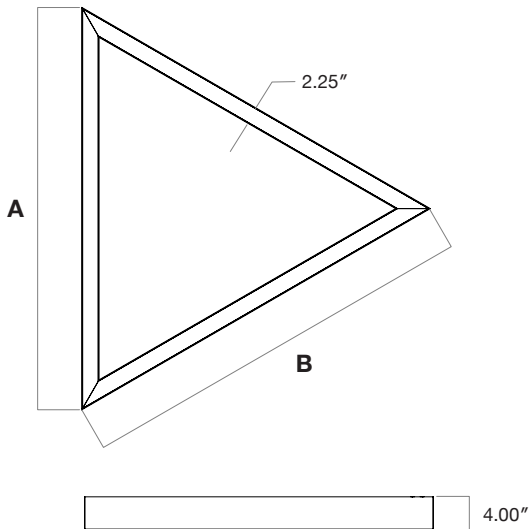

MODEL	A	B
2 x 2FT	28.4"	28.4"
3 x 3FT	40.4"	40.4"
4 x 4FT	52.4"	52.4"

Mounting

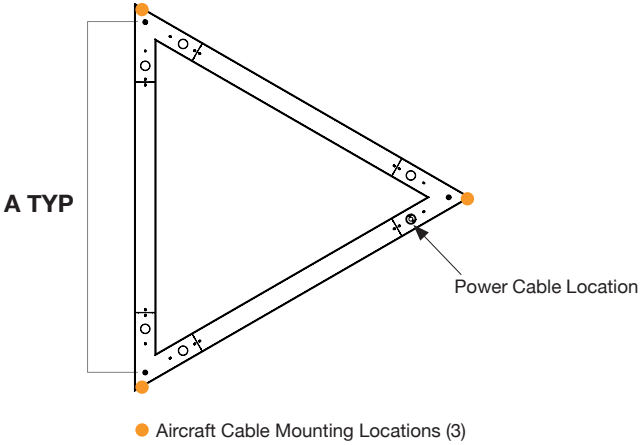





MODEL	A
2 x 2FT	24.5"
3 x 3FT	36.5"
4 x 4FT	48.5"

Finish Options

Standard Finishes

	Grey RAL 7046 Sandtex		White RAL 9003 Sandtex		Black RAL 9004 Sandtex
-------------------------------------------------------------------------------------	-----------------------------	-------------------------------------------------------------------------------------	------------------------------	-------------------------------------------------------------------------------------	------------------------------

Custom Finishes

	Orange RAL 2009 Sandtex		Green RAL 6010 Sandtex		Blue RAL 5012 Sandtex		Yellow RAL 1037 Sandtex
-------------------------------------------------------------------------------------	-------------------------------	-------------------------------------------------------------------------------------	------------------------------	-------------------------------------------------------------------------------------	-----------------------------	-------------------------------------------------------------------------------------	-------------------------------

Additional finishes - Please contact factory