

DTL Boom Series Wall Mount

Features

- Architectural luminaire
- Wall mount
- Sleek minimal design
- Direct, Direct/Indirect distributions
- 3 model options
- Multiple RAL and decorative paint finishes
- Dry and damp rated for indoor applications
- Designed and Manufactured in North America
- 5 Year Warranty

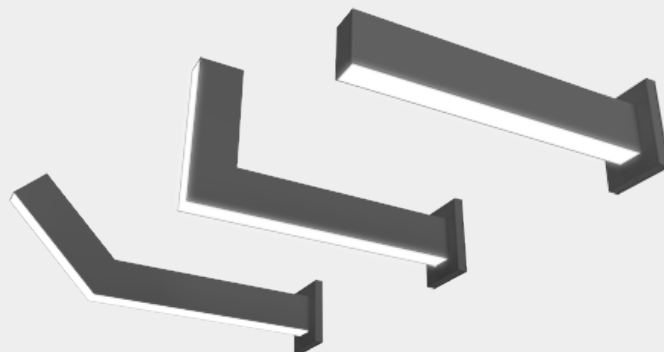

Specifications

Construction

Aluminum Extruded Body
Cast End Caps with Light Block

LED

Samsung LM281B Plus Pro, 3-Step MacAdam Binning
4000K - 130 Lm/W
3500K - 98%
3000K - 95%
L90>70,000

Lumens/Ft - Direct/Indirect

Min: 250 Lm/ft - Max: 1200 Lm/ft

Color Temperature

2700K - 5000K

CRI

80 or 90

Voltage

120/277V or 347V

Driver

0-10V Dimming down to 1%, DALI, Lutron, ELDO

Lens

Frosted Flat
Batwing (indirect only)

Mounting

Wall mount

Wiring

5 Leads
5 Wire

Finishes

RAL
Decorative Paint (Custom)

Certifications

cULus



Date	Fixture	Notes
<input type="text"/>	<input type="text"/>	<input type="text"/>
Project		<input type="text"/>
<input type="text"/>		<input type="text"/>

Ordering Guide

Sample Configuration: DTL Boom - 500 - 90 - 4K - U - FR - BLK - WM - DIMOFF - N

<input type="text"/>	<input type="text"/>	<input type="text"/>	<input type="text"/>	<input type="text"/>	<input type="text"/>	<input type="text" value="FR"/>	<input type="text"/>	<input type="text"/>
Model	Direct Lm/Ft	Indirect Lm/Ft	CRI	Color Temp	Voltage	Direct Lens	Indirect Lens	Finish (RAL)
<input type="text"/>	<input type="text" value="WM"/>	<input type="text"/>	<input type="text"/>	<input type="text"/>	<input type="text"/>	<input type="text"/>	<input type="text"/>	<input type="text"/>
Decorative Paint	Mounting	Driver	Wiring					

Model	Direct Lm/Ft	Indirect Lm/Ft	CRI	Color Temp	Voltage	Lens - Direct
DTL Boom DTL Boom 90 DTL Boom 135	D 250 (min) - D 1200 (max)	D 250 (min) - D 1200 (max)	80 90	27K - 2700K 3K - 3000K 35K - 3500K 4K - 4000K 5K - 5000K	U - 120/277V H - 347V	FR - Frosted Flat

Lens - Indirect	Finish RAL	Decorative Paint	Mounting
FR - Frosted Flat BATWING - Batwing	WH - White BLK - Black GRY - Grey CU - Custom* Note: For custom finishes please specify RAL number (pg.4)	Please specify finish name (pg. 5) Additional finishes available - please contact factory Note: Minimum Order Quantity (MOQ required). Please contact factory for more information	WM - Wall Mount

Driver	Wiring		
DIMOFF - 0-10V Dimming down to 1% Optional DALI - Digital Addressable Lighting Interface LUTRON - Lutron Ecosystem ELDO - Dim to 0.11% ELDO (347 only 1-10 5%)	N - 5 Leads Optional 5 WIRE - 5 Wire		

Dimensions

DTL Boom

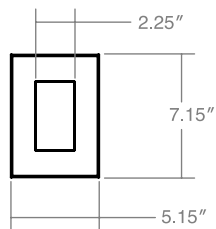
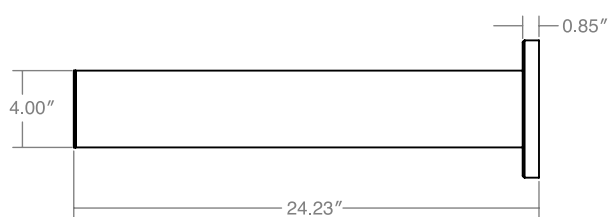

DTL Boom 90

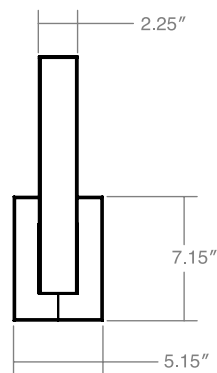
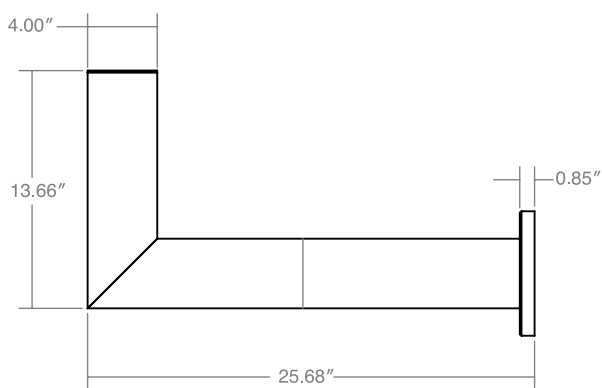

DTL Boom 135

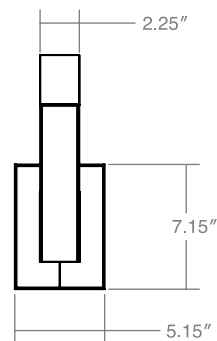
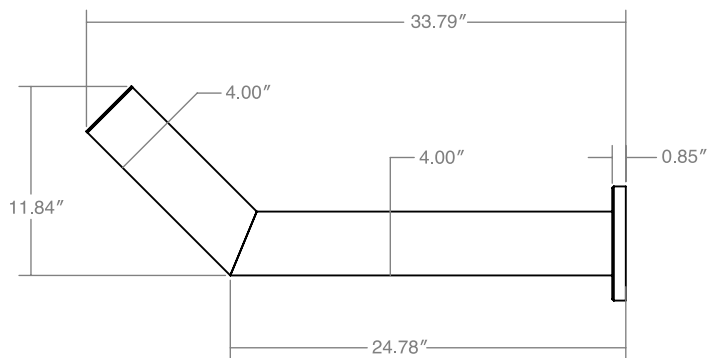

Mounting

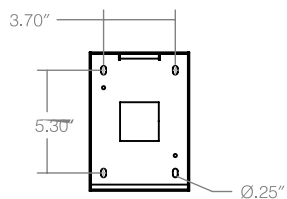

RAL Finish Options

Standard Finishes



Signal White
RAL 9003

Telegrey 2
RAL 7046

Signal Black
RAL 9004

Sample Custom Finishes



Traffic White
RAL 9016

Papyrus White
RAL 9018

Graphic Grey
RAL 7024

Jet Black
RAL 9005

Graphic Black
RAL 9011

Azure Blue
RAL 5009

Gentian Blue
RAL 5010

Sky Blue
RAL 5015



Pastel Orange
RAL 2003

Pure Orange
RAL 2004

Lemon Yellow
RAL 1012

Zinc Yellow
RAL 1018

Coral Red
RAL 3016

Rose
RAL 3017

Traffic Red
RAL 3020

Salmon Pink
RAL 3022



Olive Green
RAL 6003

Grass Green
RAL 6010

Claret Violet
RAL 4004

Traffic Purple
RAL 4006

Pearl Blackberry
RAL 4012

Beige
RAL 1001

Nut Brown
RAL 8011

Sepia Brown
RAL 8014



Additional RAL Finishes

Please Contact Factory

Decorative Paint

Sample Finishes

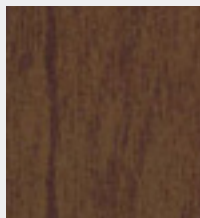

Teak
Dark Brown
Textured Matte



Douglas
Light Brown
Textured Matte



Pine
Light Brown
Textured Matte



Cherry
Light Brown
Smooth Matte



Oak
White
Smooth Matte



Bamboo
Light Brown
Smooth Matte

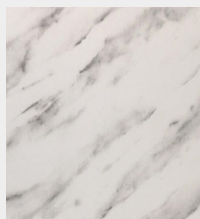

Marble
White
Smooth Matte



Marble
Dark Brown
Smooth Glossy



Stone
Grey
Smooth Matte



Stone
Grey
Icetouch



Brushed
Grey
Textured Matte



Spatulated
Grey
Smooth Glossy

Note:

- Minimum Order Quantity (MOQ) required. Please contact factory for more information.
- Please contact factory lead times and additional finishes