

Date	Fixture	Project	Quantity
------	---------	---------	----------

Airflex

High Bay

Features

- Commercial LED high bay
- Pendant mounting
- Suitable for warehouses, gymnasiums, industrial facilities, and box stores
- 2' and 4' lengths
- Dry and damp rated
- Designed and Manufactured in North America
- 5 Year Warranty

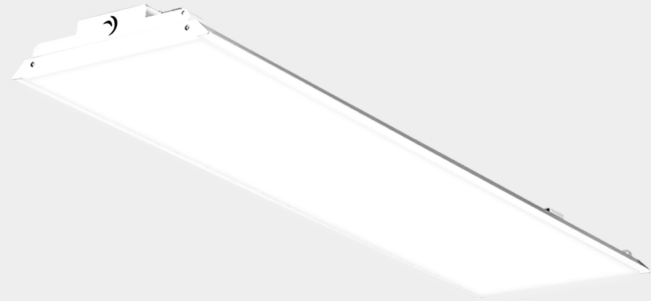

Specifications

Construction

Formed Steel Housing
Powder Coated Finish

Dimensions: WxLxH

Airflex 2: 9.5" x 23.75" x 3.25"
Airflex 4 (S): 6" x 46.5" x 3.25"
Airflex 4 (M): 9.5" x 46.5" x 3.25"
Airflex 4 (L): 13.5" x 46.5" x 3.25"

LED

Samsung LM281B Plus Pro, 3-Step MacAdam Binning
L90>200,000

Efficacy

Airflex 2: Up to 156 Lm/W
Airflex 4: Up to 154 Lm/W

Watts

Airflex 2: 80W - 190W
Airflex 4: 80W - 480W

Color Temperature

3000K - 5000K

CRI

80 or 90

Voltage

120/277V or 347/480V

Controls

0-10V Dimming down to 1%

Operating Temperature

-25°C to +40°C
-13°F to +104°F

Lens Options

No Lens
Clear
Frosted
Glare Reducing

Mounting

Aircraft Cable (10' std)
V-Hooks

Accessories

Occupancy Sensor (on/off)
Bi-Level Dimming (100%/10%)
10kV Surge Protection,
Emergency Battery
60° Aisle Reflector

Wiring

Black or White Flexible Cord

Finishes

White - RAL 9003

Certifications

DLC Premium
DLC
cULus

Not all products are qualified on the DLC QPL. To view our DLC qualified products, please consult the DLC qualified products list at www.designlights.org/qpl.



Ordering Guide

Sample Configuration: Airflex - 2 - 95 - 80 - 4K - FR - 4K - U - FR - WH - AC - BFC - N - N - IB

Model	Length	Watts Airflex 2	Watts Airflex 4	CRI	Color Temp	Voltage	Lens	Finish	Mounting
Wiring	Accessories	Reflector	Packaging						

Model	Length	Watts (Airflex 2)	Watts (Airflex 4)	CRI	Color Temp	Voltage	Lens	Finish
AIRFLEX	2	80	80	80	3K - 3000K	U - 120/277V	NL - No Lens Standard <i>Optional</i> FR - Frosted G - Glare Reducing CL - Clear (Shatterproof Polycarbonate)	WH - White
	4	95	95	90	35K - 3500K	H - 347/480V		
		110	110		4K - 4000K			
		135	135		5K - 5000K			
		160	160					
		190	190					

Mounting	Wiring	Accessories	Reflector	Packaging
AC - Aircraft Cable V - V Clips	BFC - Black Flexible Cord WFC - White Flexible Cord	N - None <i>Optional</i> OCC - Occupancy Sensor (on/off) EM - Emergency Battery BLD - Bi-Level Dimming (100%/10%) 10kV - 10kV Surge Protection	N - None <i>Optional</i> 60AR - 60° Aisle Reflector	IB - Individually Boxed SKE - Skidded with End Caps

Dimensions

Airflex 2

Models: 80, 95, 110, 135, 160, 190

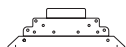

W: 9.5"
H: 3.25"



L: 23.75"

Airflex 4

Models: 80, 95, 110



W: 6"
H: 3.25"



L: 46.5"

Airflex 4

Models: 135, 160, 190, 240, 320

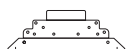

W: 9.5"
H: 3.25"

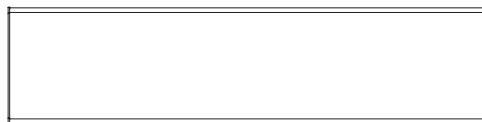

L: 46.5"

Airflex 4

Models: 400, 480

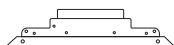

W: 13.5"
H: 3.25"

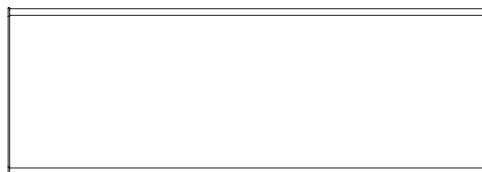

L: 46.5"

Output Performance

Model	Watts	Lm/W	Delivered Lumens
Airflex 2 80	75.85	151	11454
Airflex 2 95	92.03	142.1	13073
Airflex 2 110	107.6	143.1	15401
Airflex 2 135	129.9	145.5	18901
Airflex 2 160	151.7	150.5	22827
Airflex 2 190	180.14	156.4	28168

Model	Watts	Lm/W	Delivered Lumens
Airflex 4 80	76.45	149.5	11432
Airflex 4 95	92.03	151.1	13909
Airflex 4 110	107.6	152.3	16386
Airflex 4 135	129.9	145	18822
Airflex 4 160	153.96	149.1	22963
Airflex 4 190	191.46	151	28909
Airflex 4 240	228.95	152.2	34854
Airflex 4 320	303.93	153.8	46744
Airflex 4 400	378.92	143	54222
Airflex 4 480	452.6	136.3	61700

Mounting V Hooks

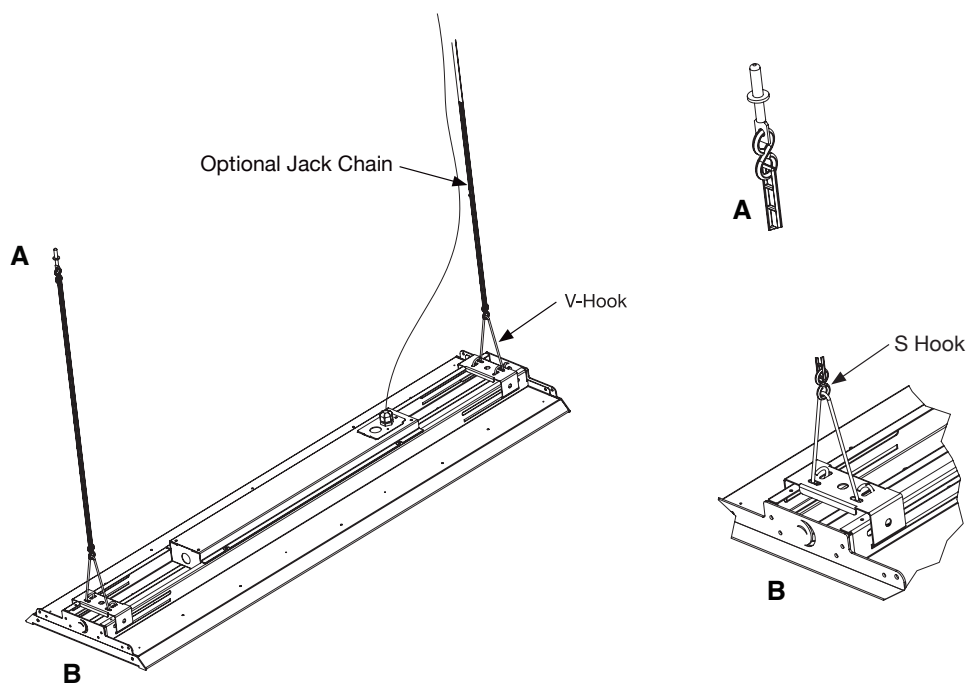

Mounting Aircraft Cable w/ Hooks

