

Fixture: \_\_\_\_\_ QTY: \_\_\_\_\_ Project : \_\_\_\_\_

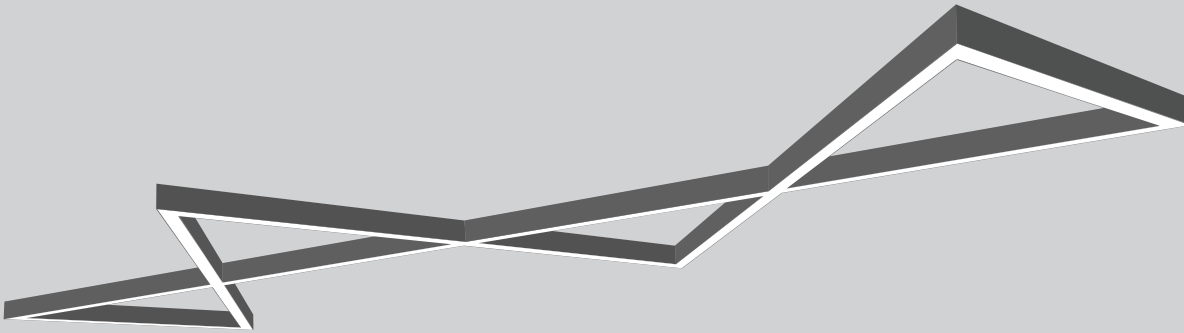

# Triangle Line

## Combinations | Modular Lighting System



Architectural lighting. Modern and contemporary design. Linear line combinations.

Modular design with intersecting aluminum extruded segments. Pendant mounting with direct, direct-indirect distribution options. 2.25" cross section. Multiple size and finish options.

cULus certified

Designed and manufactured in North America  
5-Year Warranty

### Performance

4000K - 120 Lm/W | 3500K - 116 Lm/W | 3000K - 112 Lm/W

### LED

L90>70,000

Samsung 301 3-Step MacAdam Binning

3500K - 98% | 3000K - 96% | 3000K - 85%

### Lens Options

Direct Distribution

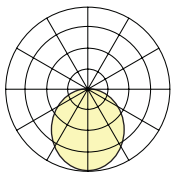

Standard  
Frosted Flat

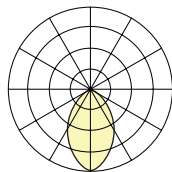

Frosted  
0.25" Regressed

### Lens Options

Indirect Distribution

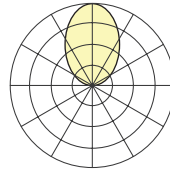

Standard  
Frosted

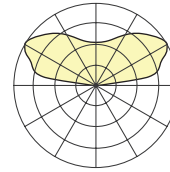

Batwing

## Linear Combinations

### Line

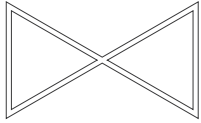

Line 2

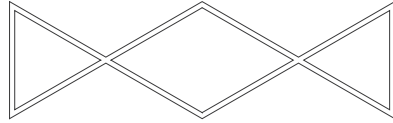

Line 4

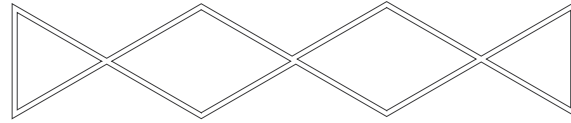

Line 6

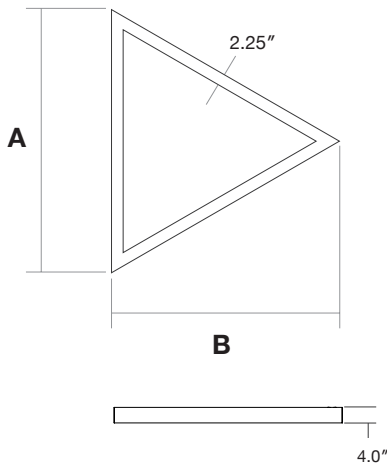

#### Triangle Dimensions

| Triangle Size | A      | B      |
|---------------|--------|--------|
| 4Ft           | 52.4"  | 45.4"  |
| 6Ft           | 76.4"  | 66.15" |
| 8Ft           | 100.4" | 86.95" |

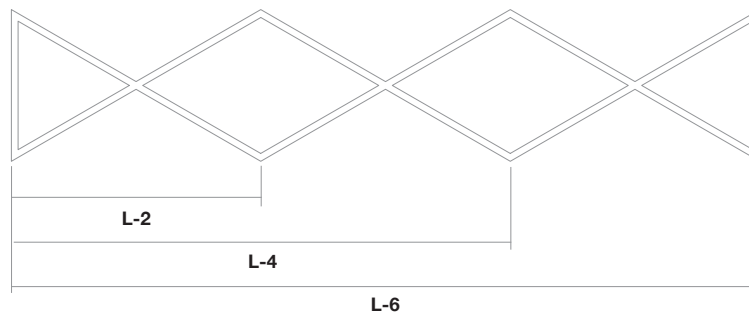

#### Triangle-Line Dimensions

| Triangle Size | L-2    | L-4     | L-6     |
|---------------|--------|---------|---------|
| Tri: 4Ft      | 86.25" | 170.25" | 254.25" |
| Tri: 6Ft      | 127.8" | 253.4"  | 379.0"  |
| Tri: 8Ft      | 169.4" | 336.55" | 503.7"  |

Note: Custom combinations (lengths) available

## Wave-Line

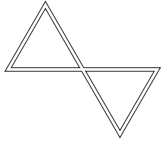

Wave-Line 2

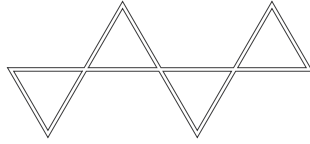

Wave-Line 4

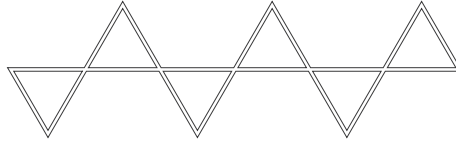

Wave-Line 6

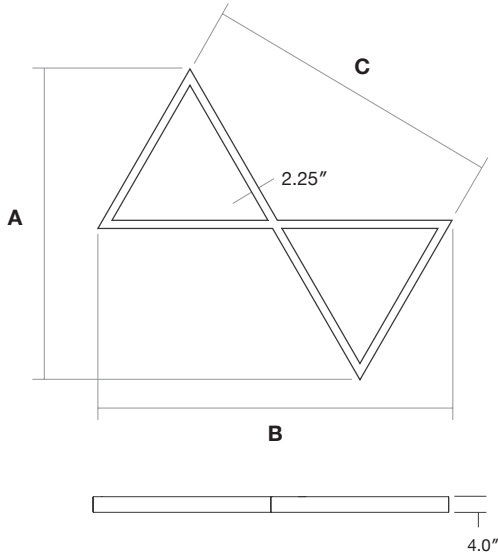

Triangle (2 units) Dimensions

| Triangle Size | A       | B      | C      |
|---------------|---------|--------|--------|
| Tri: 4Ft      | 88.5"   | 100.9" | 86.25" |
| Tri: 6 Ft     | 130.7"  | 148.9" | 127.8" |
| Tri: 8 Ft     | 171.65" | 196.9" | 169.4" |

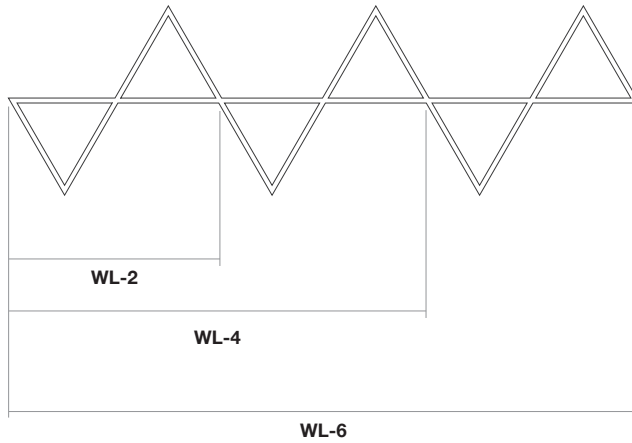

Wave-Line Dimensions

| Triangle Size | WL-2   | WL-4   | WL-6   |
|---------------|--------|--------|--------|
| Tri: 4Ft      | 100.9" | 197.9" | 294.9" |
| Tri: 6 Ft     | 148.9" | 293.9" | 438.9" |
| Tri: 8 Ft     | 196.9" | 389.9" | 582.9" |

Note: Custom combinations (lengths) available

### Ordering Options

**Sample Configuration:** DTL TRI - Line: L 2 - 4Ft - D 250 - I 250 - 80 - 4K - U - FR - FR - WH - AC - DIMOFF - N - 2 - N - 5WIRE - CL - 6 - WH

| Model   | Line Combinations |                   | Triangle Size              | Direct Lm/ft               | Indirect Lm/ft | CRI       | Color Temp       |
|---------|-------------------|-------------------|----------------------------|----------------------------|----------------|-----------|------------------|
| DTL TRI | <b>Line:</b>      | <b>Wave-Line:</b> | <b>4Ft</b>                 | <b>D 250</b>               | <b>I 250</b>   | <b>80</b> | <b>27K 2700K</b> |
|         | L 2               | WL 2              | <b>6Ft</b>                 | <b>D 500</b>               | <b>I 500</b>   | <b>90</b> | <b>3K 3000K</b>  |
|         | L 4               | WL 4              | <b>8Ft</b>                 | <b>D 750</b>               | <b>I 750</b>   |           | <b>35K 3500K</b> |
|         | L 6               | WL 6              | <i>Note: Triangle Side</i> | <b>D 1000</b>              | <b>I 1000</b>  |           | <b>4K 4000K</b>  |
|         | Custom            | Custom            |                            | <b>D _____</b>             | <b>I _____</b> |           | <b>5K 5000K</b>  |
|         | TRI: _____        | Wave: _____       |                            | <i>(custom up to 1200)</i> |                |           |                  |

|                |                 |                 |  |  |  |  |  |
|----------------|-----------------|-----------------|--|--|--|--|--|
| <b>DTL TRI</b> | TRI-Line: _____ | TRI-Line: _____ |  |  |  |  |  |
|----------------|-----------------|-----------------|--|--|--|--|--|

| Voltage                            | Direct Lens  | Indirect Lens                               | Finish  | Mounting                              | Driver   |
|------------------------------------|--|---|---|---------------------------------------|--|
| <b>U</b> 120/277V<br><b>H</b> 347V | <b>FR</b> Frosted Flat<br><b>FRREG</b> Frosted Regressed | <b>FR</b> Frosted<br><b>BATWING</b> Batwing | <b>WH</b> White<br><b>BLK</b> Black<br><b>GRY</b> Grey<br><b>CU</b> Custom<br><br><i>- For custom finishes please specify RAL number<br/>- See Finish Options</i> | <b>AC</b> Aircraft Cable<br>10' (Std) | <b>DIMOFF</b> 0-10V DIMOFF<br><br><i>Optional</i><br><b>DALI</b> Digital Addressable Lighting Interface<br><b>LUTRON SR</b> Lutron Ecosystem Philips SR<br><b>ELDO</b> .1% ELDO (347 only 1-10 5%) |

|  |  |  |  |           |  |
|--|--|--|--|-----------|--|
|  |  |  |  | <b>AC</b> |  |
|--|--|--|--|-----------|--|

| Controls  | Circuits                                  | Accessories   | Wiring  | Wire Color   |
|---|---|---|---|--|
| <b>N</b> None<br><i>Optional</i><br><b>DMX</b> Digital Multiplex<br><b>SNS</b> Philips SNS 300 w/BLD & Daylight<br><b>CLM</b> Encelium CLM<br><b>LG</b> LG Dongle<br><b>BT</b> Bluetooth Mesh<br><b>EN</b> Enlighted Integral | <b>1</b> 1 Circuit<br><b>2</b> 2 Circuits | <b>N</b> None<br><i>Optional</i><br><b>10kV</b> 10kV Surge Protection<br><b>EM</b> Emergency Battery<br><b>+GTD</b> Generator Transfer Device | <b>5 WIRE</b> 5 Wire - Cable (Std)<br><i>Optional</i><br><b>N</b> 5 Leads<br><b>6 WIRE</b> 6 Wire - Cable (EM - emergency battery option) | <b>CL</b> Clear<br><i>Optional</i><br><b>B</b> Black<br><b>W</b> White |

|  |  |  |  |  |
|--|--|--|--|--|
|  |  |  |  |  |
|--|--|--|--|--|

| Wire Length                      | Canopy Color   |
|----------------------------------|--|
| <b>Length(Ft)</b><br>- 6Ft (Std) | <b>WH</b> White<br><b>BLK</b> Black<br><b>CU</b> Custom<br><br><i>- For custom finishes please specify RAL number<br/>- See Finish Options</i> |

|  |  |
|--|--|
|  |  |
|--|--|

## Finish Options

### Standard RAL Finishes



**Signal White**  
RAL 9003

**Telegrey 2**  
RAL 7046

**Signal Black**  
RAL 9004

### Sample Custom RAL Finishes

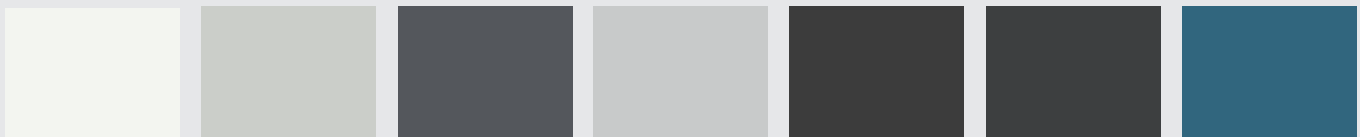

**Traffic White**  
RAL 9016

**Papyrus White**  
RAL 9018

**Graphic Grey**  
RAL 7024

**Light Grey**  
RAL 7035

**Jet Black**  
RAL 9005

**Graphic Black**  
RAL 9011

**Azure Blue**  
RAL 5009



**Gentian Blue**  
RAL 5010

**Sky Blue**  
RAL 5015

**Pastel Orange**  
RAL 2003

**Pure Orange**  
RAL 2004

**Daffodil Yellow**  
RAL 1007

**Lemon Yellow**  
RAL 1012

**Zinc Yellow**  
RAL 1018



**Coral Red**  
RAL 3016

**Rose**  
RAL 3017

**Traffic Red**  
RAL 3020

**Salmon Pink**  
RAL 3022

**Olive Green**  
RAL 6003

**Moss Green**  
RA 6005

**Grass Green**  
RAL 6010

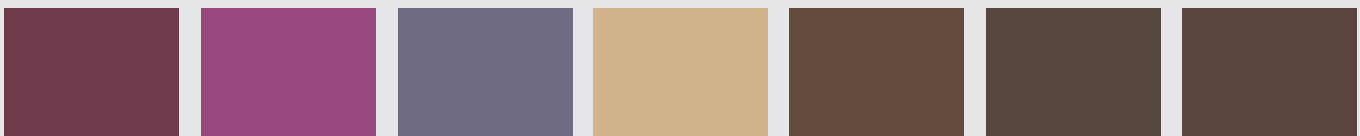

**Claret Violet**  
RAL 4004

**Traffic Purple**  
RAL 4006

**Pearl Blackberry**  
RAL 4012

**Beige**  
RAL 1001

**Nut Brown**  
RAL 8011

**Sepia Brown**  
RAL 8014

**Mahogany Brown**  
RAL 8016

Custom Finishes - Please contact factory

Additional Finishes Available - Please contact factory